

WIRE SHELVING 14" x 36" x 54" FOUR SHELF / CHROME

WSW-143654-4C

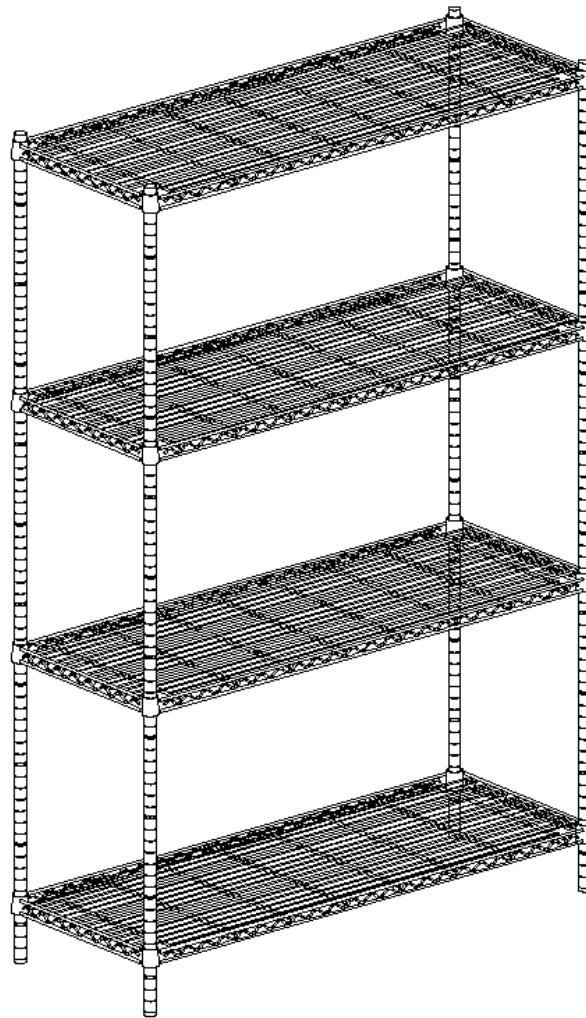

“ADULT ASSEMBLY REQUIRED DUE TO THE PRESENCE OF SMALL PARTS, SHARP POINTS, SHARP EDGES AS RECEIVED”



Organize your life.



Certified for safe storage of food, water
and other goods by NSF International.

Please call for replacement parts or assistance: **1-866-942-5362**
Pacific Standard Time: 8:30 am – 4:30 pm Monday to Friday
Or visit our web site www.whalenstorage.com

Factory No.: 14444

Page # 1

Parts List

Please read completely through the instructions and verify that all parts listed are present before beginning assembly.

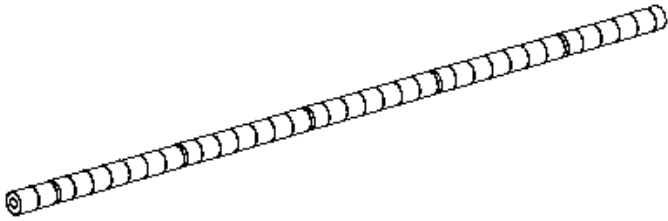

A- Lower Post (4-ea.)

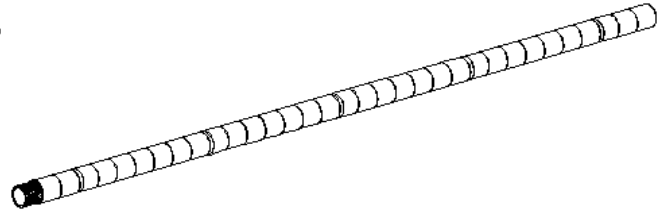

B- Upper Post (4-ea.)

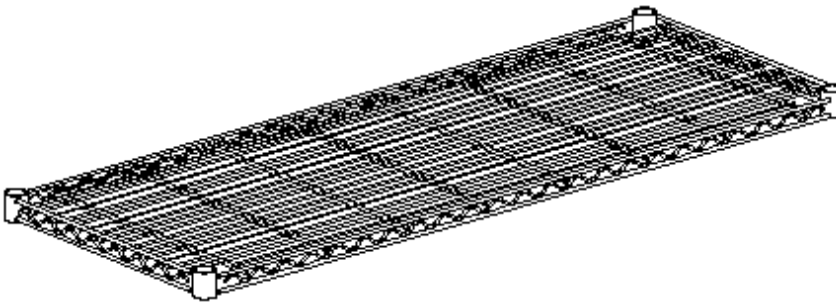

C- Wire Deck (4-ea.)

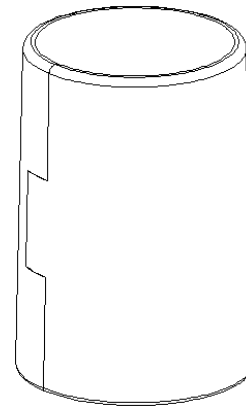

D- Plastic Brackets (16-ea.)



E- Tipping Restraint Hardware (2-ea.)

Tool Required: Rubber Mallet, hammer, Phillips screwdriver, and power drill

Please call for replacement parts or assistance: 1-866-942-5362

Factory No.: 14444

Page # 2

Assembly Instructions

Note: Assemble the unit on a sturdy and level surface. Avoid assembling on carpet. To facilitate assembly we recommend having two persons assemble the unit. If you do not understand these directions, or have any doubts about the safety of the installation, please call a qualified contractor or contact Whalen Storage at 1-866-942-5362. We can assist you or give you directions.

If you have any defective parts please do not use, improper installation may result in damages or injuries.

1. Unpack the unit and confirm that you have all the hardware and required parts listed. To facilitate the assembly, you could sort all parts by alphabetical order.
2. Have each pairs of Plastic Brackets (D) hooked at your desired height of each Lower Post (A). Be sure each pair of plastic brackets hooked at the same level, and then get each lower post through the tubing of Wire Deck (C) one by one. As shown in detail #1.

Note: hold plastic brackets firmly while lowering decks, a couple of taps are required. Make sure plastic brackets hooked at your desired height. And also make sure the two rings of the plastic brackets both hooked in the two grooves of the post; Every 7 grooves, there is a double-grooves, the shallower one of the double grooves is intended for assembly height identification purpose only.

Now you have a base standing there. Repeat above steps to assemble the second level.

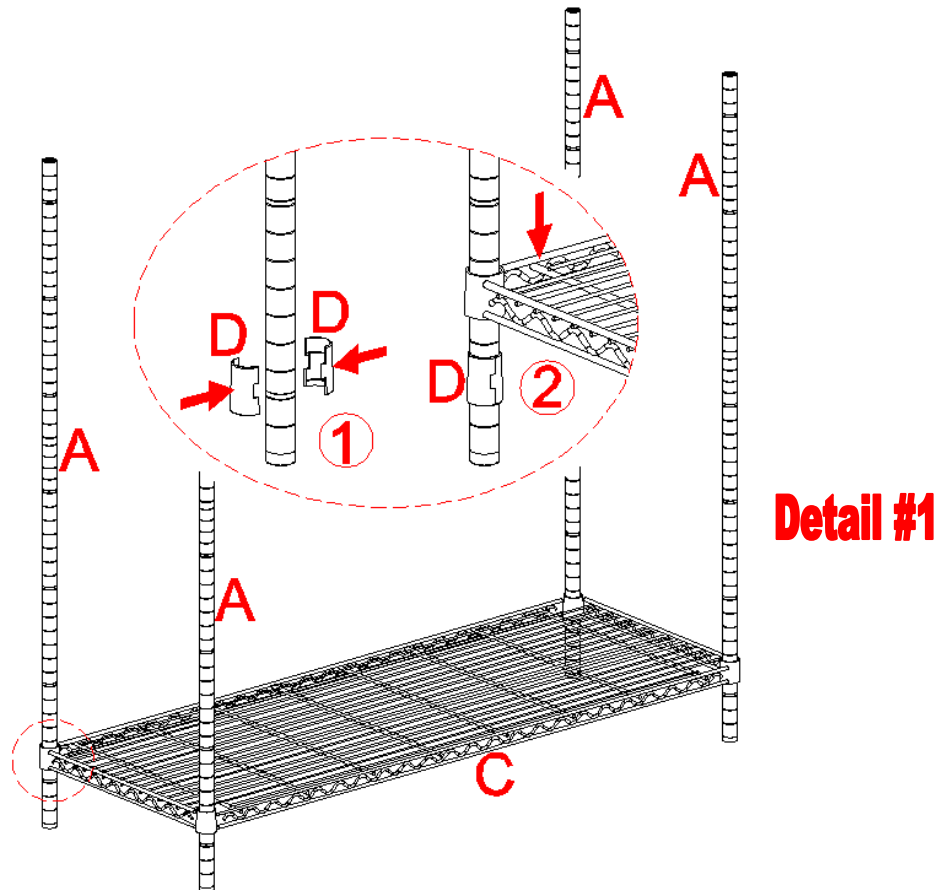

Please call for replacement parts or assistance: 1-866-942-5362

Factory No.: 14444

Page # 3

Assembly Instructions

- Extend the posts by having four Upper Posts (B) assembled. Fix each upper post to the lower post as shown in detail #2. Make sure each post is secured firmly before installing wire decks.

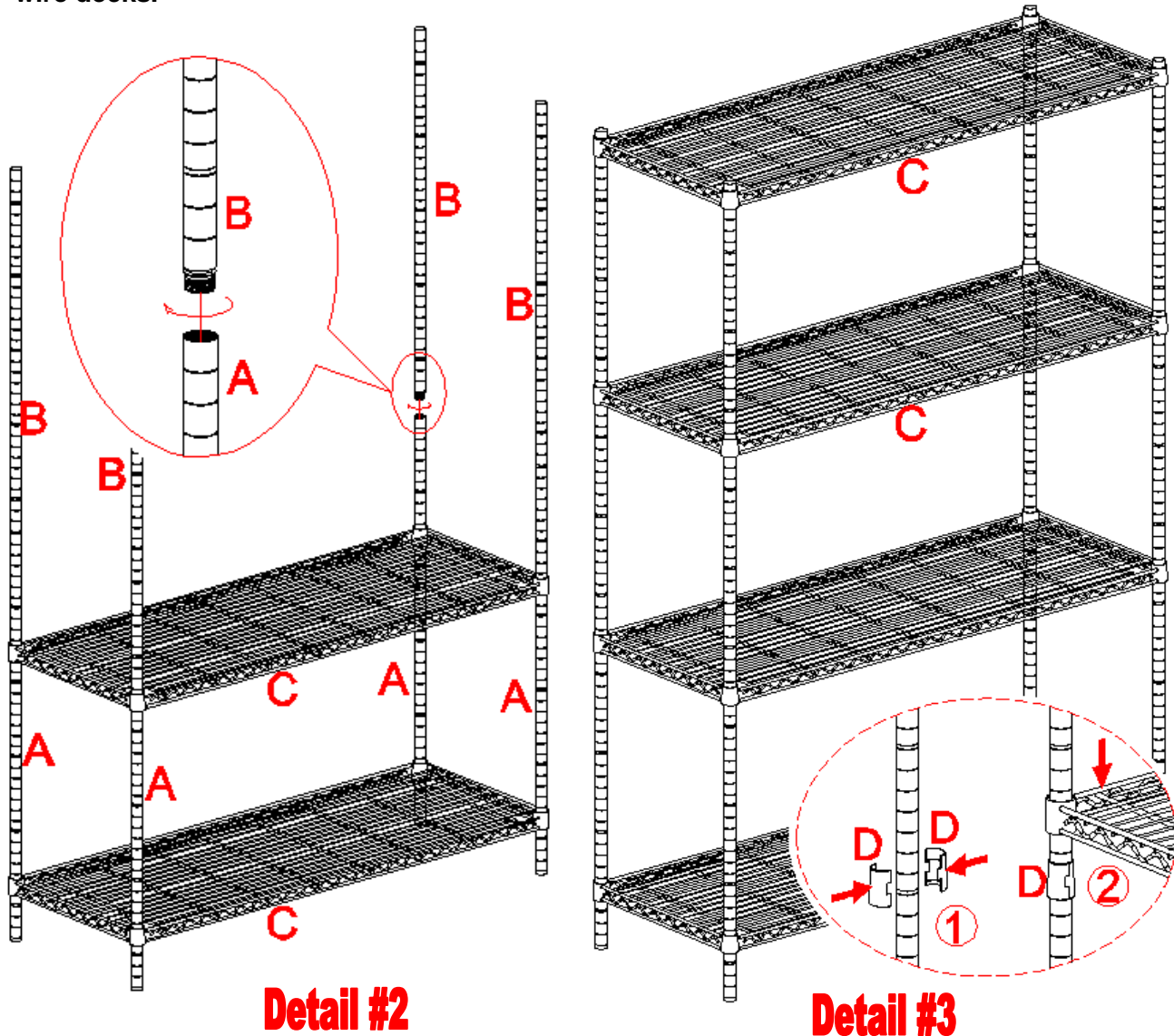

- Repeat step 2 to have level 3 and 4 assembled, as shown in detail #3.
- Adjust leveling feet as required for uneven floors.

Note: hold the posts while moving around the unit, hold the wire deck may result in unexpected disassembly.

Please call for replacement parts or assistance: 1-866-942-5362

Factory No.: 14444

Page # 4

TIPPING RESTRAINT HARDWARE

Note: We have included one Tipping Restraint Hardware bag for this Unit. When properly installed, this restraint can provide protection against the unexpected tipping of the Unit due to small tremors, bumps or climbing. We strongly recommend mounting this hardware to a wall stud and your Unit.

Please carefully read the instructions printed on the bag.

Note: You must install the Tipping Restraint Hardware with the unit in use to prevent any accidents or damage to the unit.

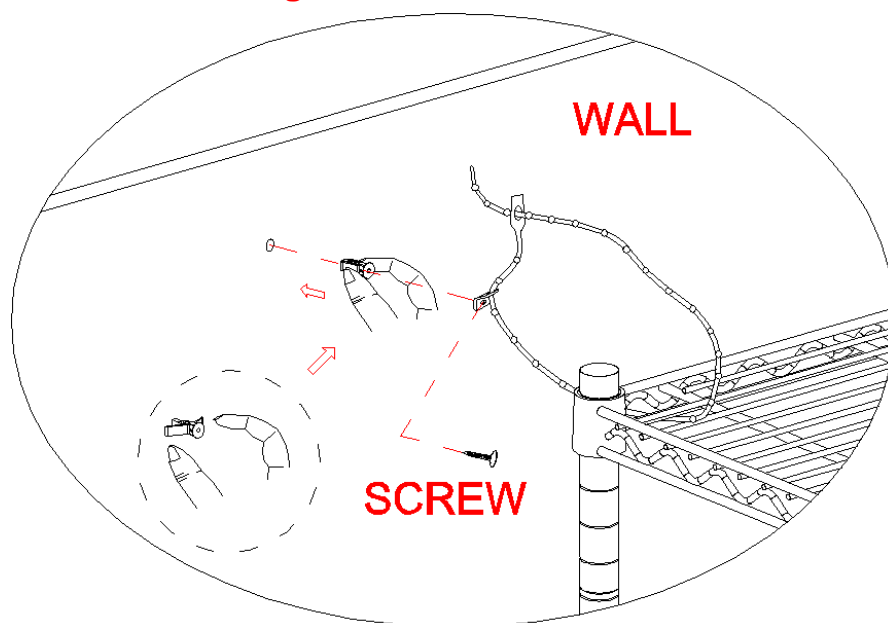

“KEEP THESE INSTRUCTIONS FOR FURTHER REFERENCE”

**Your assembly should now be complete.
Thank you for your purchase.**



Organize your life.

www.whalenstorage.com

Please call for replacement parts or assistance: 1-866-942-5362

Factory No.: 14444

Page # 5